

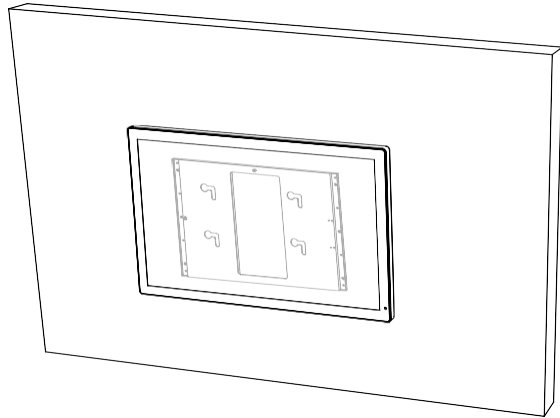











PF43/55 Mounting Plate Installation Guide



- This guide explains how to install the mounting plate for large-sized screens using screws.
- Note: Accessory 11 must be prepared by the user.

Required Accessories for Installation

1. Mounting Plate × 1		7. Quick Installation Manual × 1	
2. Mounting Plate Adapter Frame × 2		8. M3 × 5 Machine Screws × 2	
3. Connecting Frame × 1		9. M4 × 6 Three-in-One Anti-Slip Screws × 7	
4. Fixed Frame × 1		10. M6 × 14 Screws × 5	
5. M6-16 Gasket × 5		11. M8 Expansion Screws × 6 (User must source this accessory independently.)	
6. M6-30 Gasket × 5			

Safety Precautions

- Refer to the installation diagram and accessories received with the product.
- The installation steps are for reference only.
- Ensure all screws are firmly tightened during installation.
- Use within the specified size and weight range for safety.
- Install the plate on a flat wall.
- For wooden walls: Ensure a thickness of at least 3 cm and a load-bearing capacity of 100 kg.
- Suitable for 43" and 55" installations.

Installation steps

Step 1 Secure the mounting plate to a solid, load-bearing wall using M8 expansion screws.

For vertical installation, ensure the "UP" label on the short side of the mounting plate faces upwards. For horizontal installation, ensure the "UP" label on the long side of the mounting plate faces upwards. Pay special attention to horizontal alignment during installation.

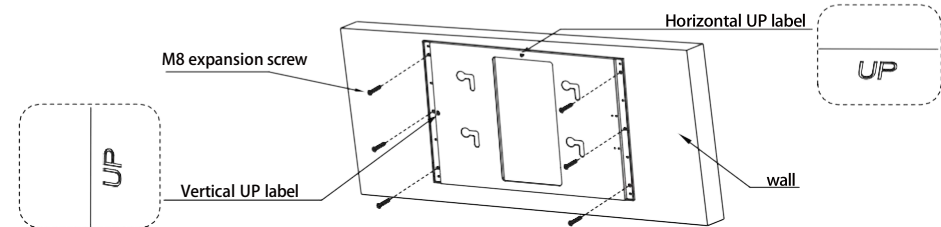

Step 2 Using M4 × 6 three-in-one screws, attach the adapter frame and connecting piece to the mounting plate as shown in the diagram.

(Note: The mounting plate adapter bracket has hole position silk screening. Select the hole size that corresponds to your screen.)

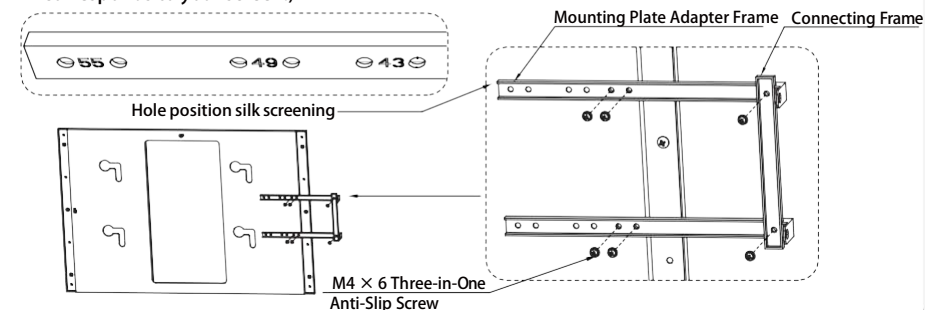

Step 3 Locate the VESA holes on the back of the machine.
Use M6 × 14 VESA screws to attach 4 M6-30 spacers and 4 M6-16 spacers to the VESA hole positions on the back of the screen.

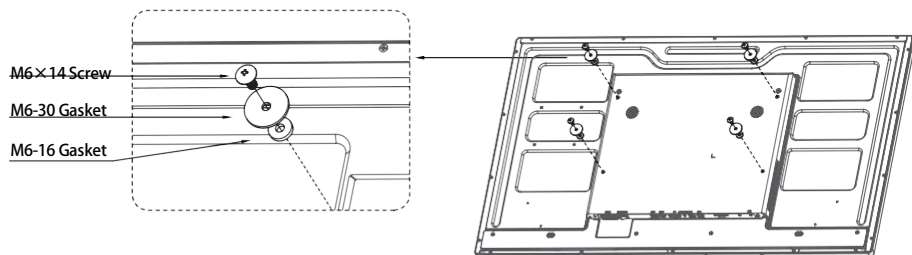

Step 4 Secure the fixed frame to the rear cover using 2 M3 × 5 round head screws.

(Note: The fixed frame also has hole position silk screening. Select the corresponding hole size based on your screen.)

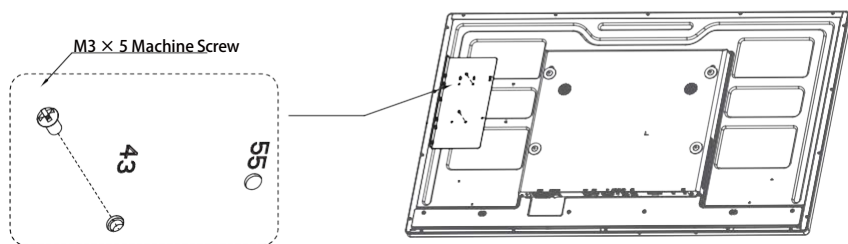

Step 5 Align the four hanging nail holes on the mounting plate with the four VESA screw centers on the back of the screen. Hang the screen securely onto the plate.

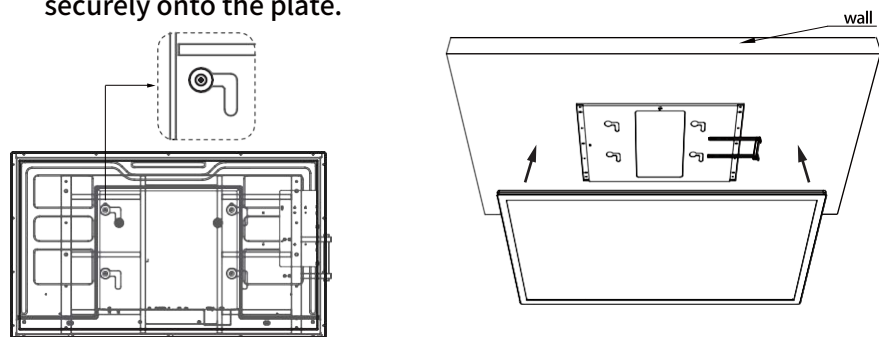

Step 6 Whilst supporting the screen with your hands, push the screen to the right, as indicated by the arrow in the installation diagram then let it slide down gently until it locks into place.

(Note: The diagram shows a front view of the screen. The mounting plate and its L-shaped holes are fixed to the wall, while the screen [with its hanging nails] moves into position.)

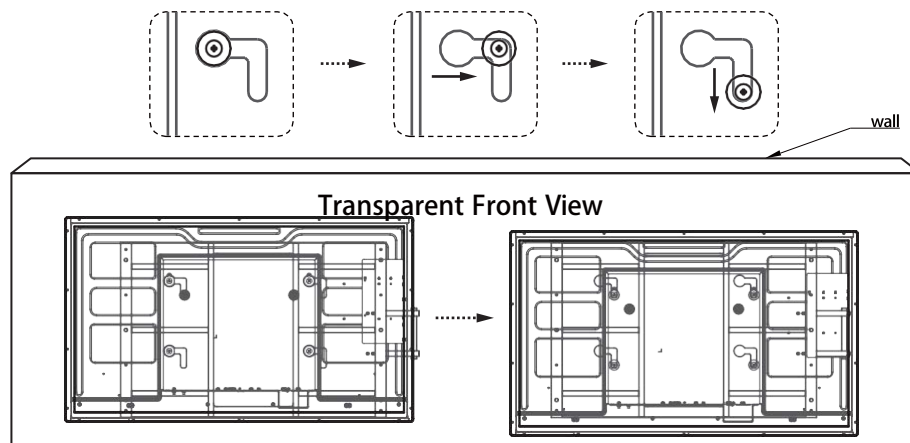

Step 7 Tighten the anti-theft screws on the side to secure the installation.

(Note: There are two anti-theft screw holes shown here. Simply choose one and tighten the anti-theft screw)

M4 × 6 Three-in-One Anti-Slip Screw
(Choose one to install)

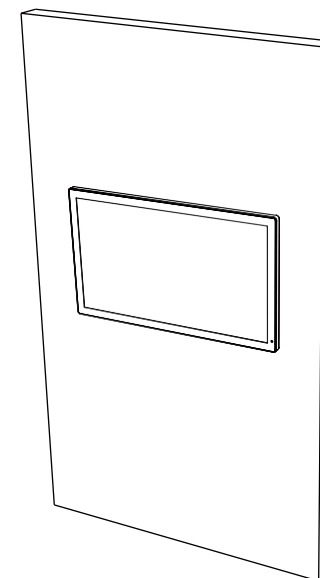
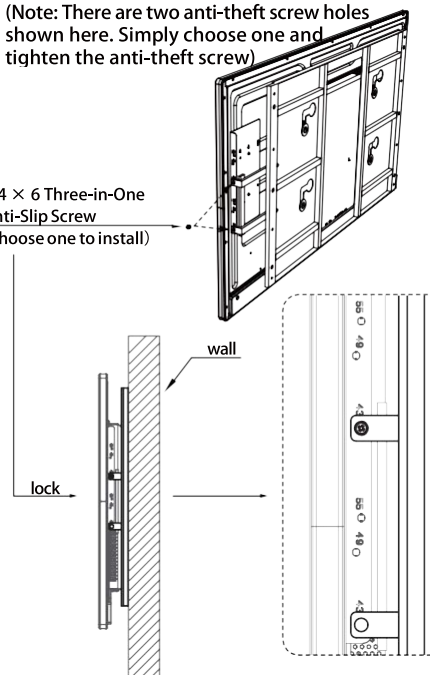

The screen is now securely installed.