

86" 4K Large Format Displays



Ultra-high definition professional monitors with built-in 4K Android media player

Lightweight Design

By using less and lighter materials this generation is considerably lighter than the previous version, making installation and maintenance much more convenient.



Remarkable 4K Display

With four times the resolution of Full HD you can achieve a truly immersive experience with an incredible image quality. The 4K resolution is now compatible with the integrated Android Media Player, our CMS software, HDMI channels and third party devices, giving you ultimate flexibility.

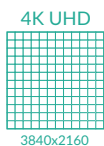
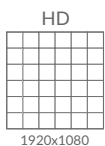

Narrow Bezel



24/7 Commercial Use



Wide Viewing Angle



Power Timer



Low Power Consumption



Integrated Speakers



Landscape/Portrait Orientation



3 Year Commercial Warranty

Other Features

24/7 Commercial Use

These displays use a commercial grade LCD panel and LED backlight. They have the ability to be in constant use 24/7 for over 70,000 hours and have no external buttons or controls to avoid tampering.



Integrated Android Media Player

There is an integrated 4K Android media player inside the screen allowing you to upgrade to a network version without needing any additional hardware. You can also install third party Android apps if required.



Plug and Play

Plug and Play is the most straightforward way to upload content to the screen. Simply load images and videos on a USB stick, insert in the display, wait for your content to copy over and then remove. Your images and videos will now play in a continuous loop.

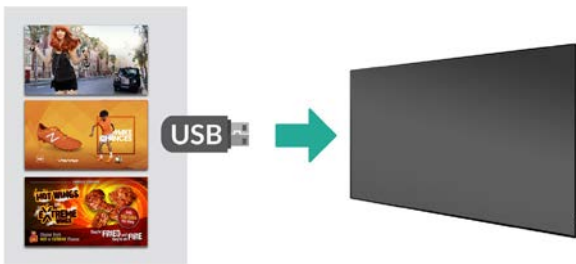

Slim Bezel

The screens feature an extremely sleek and narrow bezel meaning that the enclosure to display area ratio is very low. The front is crafted from segmented aluminium to achieve ultimate precision while the polymer rear keeps the display super slim and lightweight.



450cd/m² Commercial Panel

A commercial grade panel and components are used to ensure reliable 24/7 use in public spaces. The screen can also be used in landscape or portrait orientation.



Power Timer

The eco-friendly power timer allows you to assign daily or weekly on and off times for your screen meaning that it is only in use when it needs to be; improving your environmental efficiency.



Multiple Inputs

Should you need to use the screen as a monitor you can connect it to an external source, like a PC or media player, using the HDMI input.

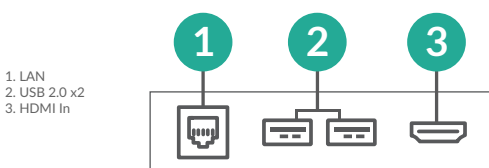

Optional Network Upgrade

For a small charge you can upgrade your screen to be networked, allowing you to connect your screen via Wi-Fi or LAN, then remotely update it over the internet.



Key Features



PLUG AND PLAY



INTEGRATED ANDROID MEDIA PLAYER



24/7 COMMERCIAL GRADE



ECO POWER TIMER



OPTIONAL NETWORK UPGRADE



LANDSCAPE OR PORTRAIT ORIENTATION



CONNECT DEVICES



SLIM BEZEL

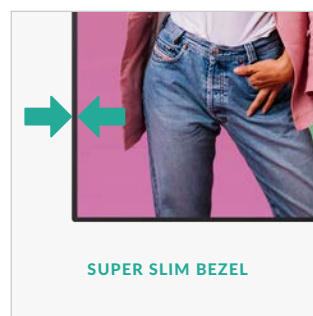
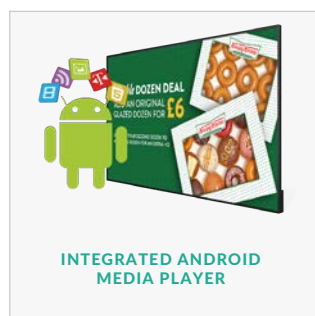
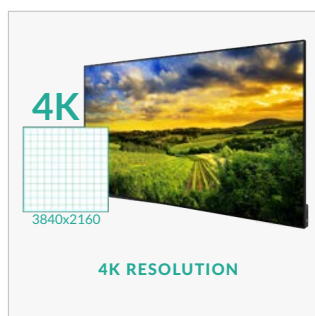

Specification Table

		86 Inch	
Panel	Resolution	3840x2160	
	Display Area (mm)	1895x1066	
	Aspect Ratio	16:9	
	Brightness (cd/m ²)	450	
	Colour	16.7M	
	Viewing Angle	178°	
	Contrast Ratio	4000:1	
Audio	Speaker Type	10W, 4Ω (x2)	
AV Inputs	Inputs	HDMI, USB 2.0 x 2	
Power	Power Consumption (W)	<285	
	Input Voltage	AC110~240V(50Hz~60Hz)	
Mechanical	Unit Size (WxHxD mm)	1940x1111x82.7	
	Package Size (WxHxD mm)	2150x1340x250	
	VESA Holes (mm)	600x800/600x600 M8	
	Net Weight (kg)	51.5	
	Gross Weight (kg)	65.3	
Environmental	Operating Temperature	0 °C to 50 °C	
	Storage Temperature	-30°C to 60°C	
	Operating Humidity	10% to 80%	
	Storage Humidity	5% to 95%	
Media Formats	Video (MPEG1/MPEG2/MPEG4/H.264/WMV/MKV/TS/FLV), Audio (MP3, ACC), Image (JPG/JPEG/BMP/PNG)		
Media Resolution	3840x2160		
Computer	CPU	RK3399 Hexa-Core 1.8GHz	
	RAM	4GB DDR3	
	Architecture	64-bit	
	Graphic Engine	ARM Mali-T864 Quad-Core	
	Hard Drive/Internal Memory (eMMC)	32GB eMMC FLASH	
	USB	USB 3.0 x 2, USB 2.0 x3	
	LAN	100/1000 Ethernet	
	Wi-Fi	802.11b/g/n/ac; 2.4G and 5G	
	OS	Android 7.1	
Accessories	Included	Remote Control, User Manual, Power Lead	
	Optional	Network Upgrade	
Warranty	Warranty Period	3 Year Warranty	
	Technical Support	Lifetime	

Errors and omissions excepted



Technical Drawing

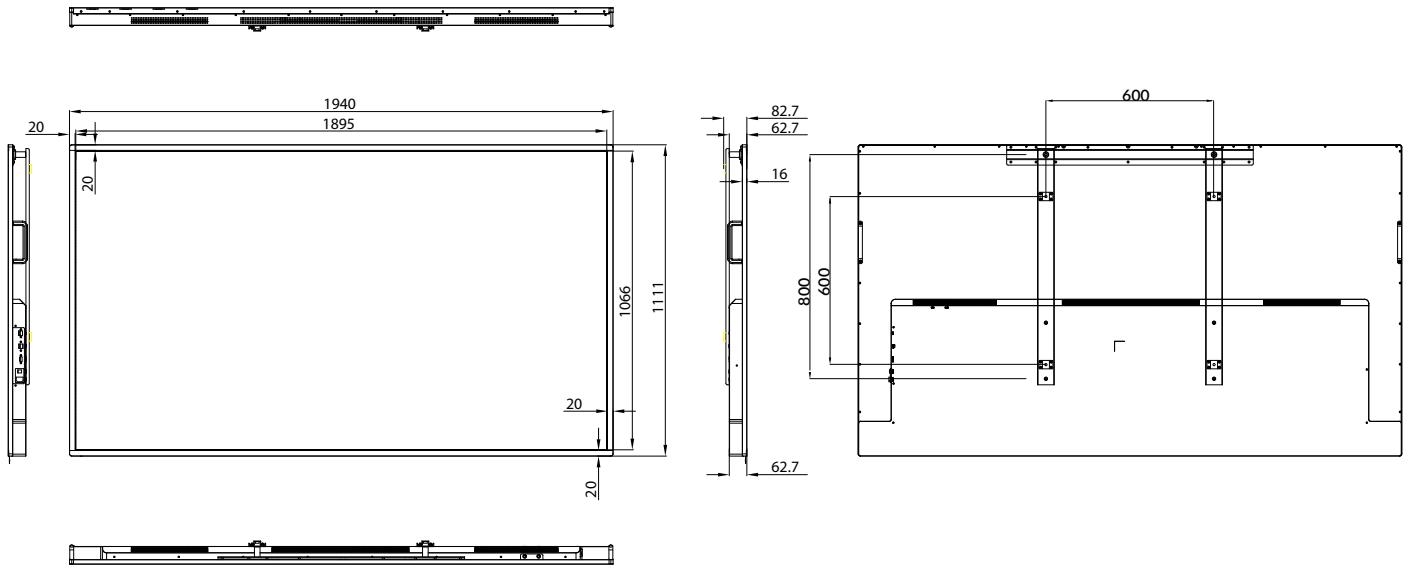

Why Choose Our Commercial Display Solutions?



Lifetime Technical Support

From the moment you receive your product, throughout the duration of your warranty and even after your warranty has expired we are here to support you. If you require any assistance setting up or using your product, or have any problems at all, we can provide free technical support via telephone and email.



On-site Support and Maintenance*

If needed, we can provide an installation service for any of our products. We can also set up service-level agreements for larger projects that require maintenance contracts.



Extended Warranty*

All of our commercial display products come with a 3 year commercial warranty as standard but if you want to extend this you can upgrade this to cover a 5 year period at point of purchase.



Training

As well as providing free remote CMS training sessions and webinars we can also visit you to deliver bespoke training for our software and hardware*.



Advanced Replacements†

Should your display suffer from any kind of hardware failure during the warranty period we will send you an advanced replacement and arrange for your old display to be collected, free of charge. This ensures no downtime where you are without a screen.



Custom Product Testing & Configuration

If you need us to test third party software or a website, or configure your screen in a particular way before it is dispatched (e.g. in a particular orientation or network mode), we can do so to make your life easier.



3D Rendering

Want to know how a particular screen will look once installed? Send us a photo of the location and we will create a 3D rendering of any screen in situ to help you to visualise how amazing it will look.



Logistics Support

We hold more stock in our UK warehouse than any other manufacturer so we can help you meet tight deadlines. For last minute orders we can also offer special express or morning delivery options*. We also carry out UK based quality control checks on every display before it leaves our warehouse.



Project Support

If you need to loan a sample unit to test we'd be more than happy to arrange this. We can also provide a rental service for temporary projects*.



Customisation*

Your display can be customised to suit your requirements by adding your logo or printed graphics or even tailoring the colour of a display. We can also carry out hardware modifications to existing products or manufacture bespoke solutions for special projects.



Extras*

As well as being able to provide accessories and add-ons, such as extra remote controls, NUC PCs and video wall controllers, we can also supply custom made flight cases which are great if a display needs to be moved safely from place to place.

†UK mainland only

*These particular services may incur additional charges