

58:9 Ultra-Wide Stretched Bar Monitors



Colossal display with unique aspect ratio that is guaranteed to grab attention and is ideal for unconventional spaces.

Extended Wide Format

This unique display is a real showstopper thanks to its 58:9 aspect ratio and 76" diagonal display area. This stretched format is perfect for mounting in spaces where conventional 16:9 displays would not fit such pillars and narrow banner gaps. The flexibility of portrait or landscape mounting offers a versatile range of possible applications.



4K Resolution (3,840 x 600)

Unlike custom DV-LED stretched displays, this solution uses a 4K LCD panel to provide a clear image and fine details. This high resolution is essential to be able to read text at close proximity and also produces the crystal clear results when showing video.

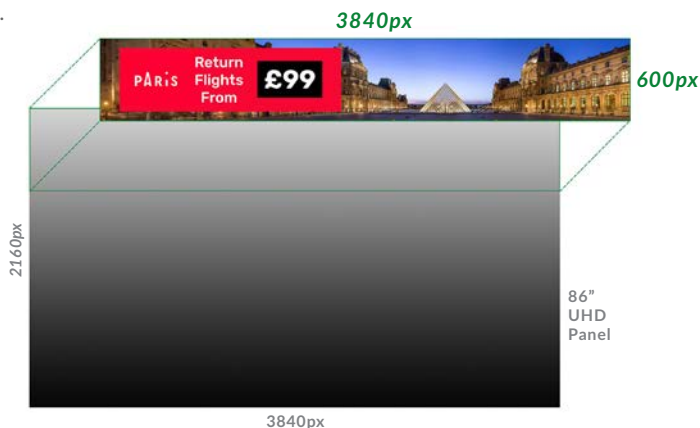

Unique Aspect ratio



Landscape/Portrait Orientation



Integrated Speakers



Clear 4K Resolution



RS-232 Control



Free Wall Mount



24/7 Commercial Grade



3 Year Warranty



Lifetime Technical Support

Other Features

Optional Android Media Player

On the rear of the screen there is space to mount our 4K Android Network Media Player or third-party media player and connect via HDMI, transforming the screen into a full Android solution.

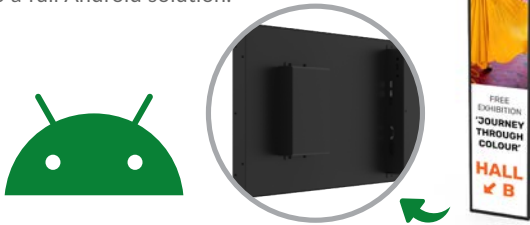

Multiple Media Zones

With the Android Media Player upgrade you can create engaging content that utilises images, videos, scrolling text and even live webpages by sectioning the display into different media zones.



Tiled Displays

Once connected to an external source you can tile the picture across multiple wide stretched monitors to create eye catching displays.

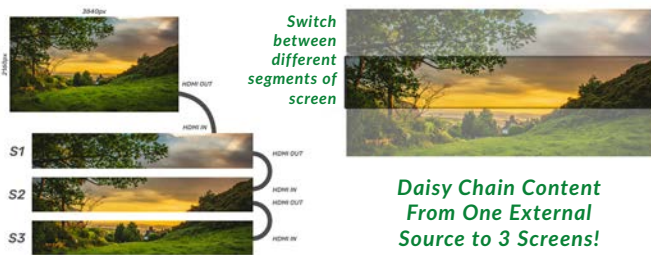

Daisy Chain Remote Commands

Once your monitors are connected via RS-232 you can control, scale and customise all of your displays remotely over short and long distances. You can daisy chain the screens together to manage multiple screens at once.



Integrated Speakers

The displays have two integrated slimline speakers for applications that involve an audio element.



Display Full Source Screen Display

Using EDID (Extended Display Identification Data), the monitor can reconfigure an external sources screen settings so the display matches the ultra wide aspect ratio perfectly and nothing is cut off.

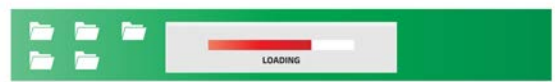

Automatic display reconfiguration of devices



User Friendly Menus

These monitors have easy to read menus that are optimised for their unique ultra-wide aspect ratio, without any distortion or the need to connect another monitor.



Integration Options

A flat wall mount, that can be used in both portrait and landscape orientation, is provided free of charge. For more custom installations, such as in retail gantries or recessed into walls, we can provide bespoke solutions on request.



Key Features



ULTRA-WIDE ASPECT RATIO



INTEGRATED SPEAKERS

4K

CLEAR 4K IMAGE



FREE WALL MOUNT



SPACE FOR MEDIA PLAYER

500CD/M² BRIGHTNESS PANEL

RS-232 MANAGEMENT

OTHER SIZES AVAILABLE



4K
3840x600

4K RESOLUTION

58:9
Aspect Ratio

ULTRA WIDE DISPLAY

OPTIONAL ANDROID MEDIA PLAYER

TILE DISPLAYS

Specification Table

		WS76M2
Panel	Resolution	3840x600
	Display Area (mm)	1895x296
	Aspect Ratio	58:9
	Brightness (cd/m ²)	500
	Colour	1.07B
	Viewing Angle	89°
	Contrast Ratio	1,200:1
AV Ports	Ports	HDMI In, HDMI Out, RS-232 In, RS-232 Out, USB (Software Updates Only)
Audio	Speaker Type	2x8Ω5W
Power	Power Consumption (W)	177
	Input Voltage	AC110~240V (50Hz~60Hz)
Mechanical	Unit Size (WxHxD mm)	1926.9x326.9x77.5
	Package Size (WxHxD mm)	2060x460x220
	VESA Holes (mm)	600x250 M6
	Net Weight (Kg)	23.2
	Gross Weight (Kg)	28.65
Environmental	Operating Temperature	-10°C to 50°C
	Storage Temperature	-20°C to 60°C
	Operating Humidity	10% to 85%
	Storage Humidity	5% to 95%
Accessories	Included	3m Power Cable, HDMI Cable, RS-232 Cable, Remote Control, User Manual, Wall Mount, Wall Mount Installation Kit
	Optional	4K Android Media Player
Warranty	Warranty Period	3 Year Warranty
	Technical Support	Lifetime

Errors and omissions excepted



Technical Drawing

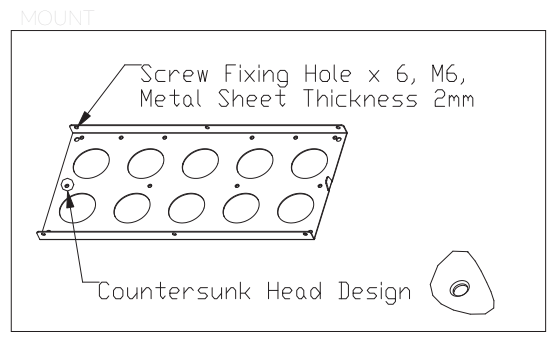
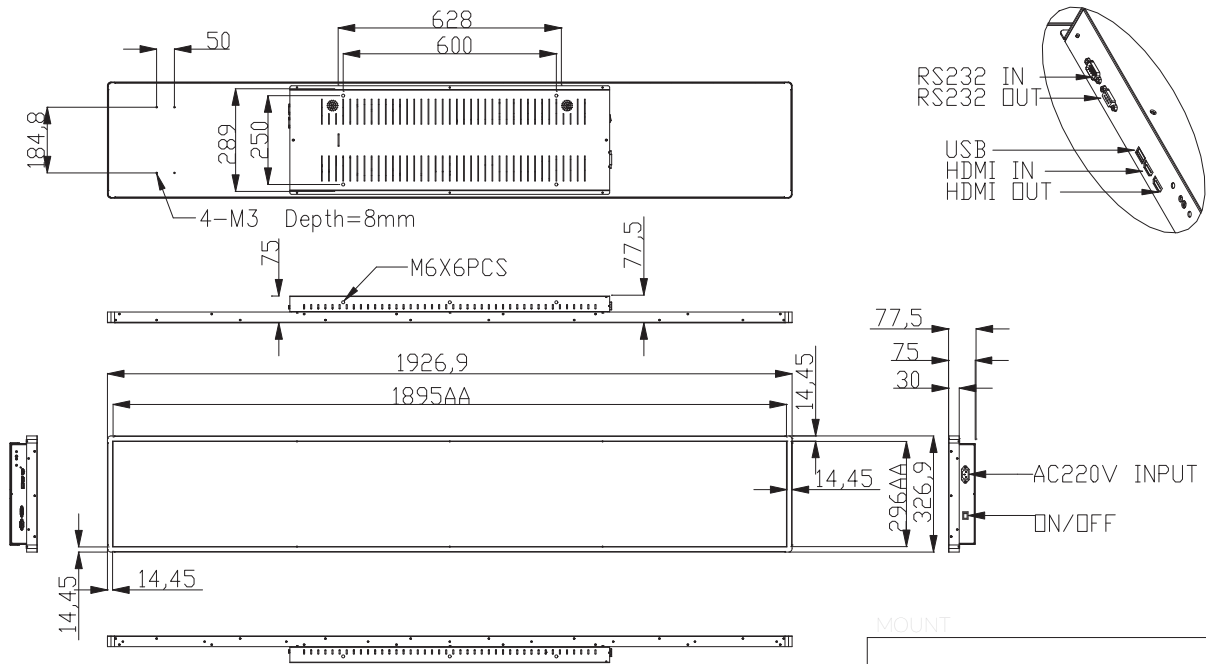

Why Choose Our Commercial Display Solutions?



Lifetime Technical Support

From the moment you receive your product, throughout the duration of your warranty and even after your warranty has expired we are here to support you. If you require any assistance setting up or using your product, or have any problems at all, we can provide free technical support via telephone and email.

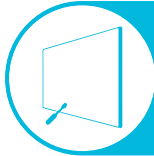

On-site Support and Maintenance*

If needed, we can provide an installation service for any of our products. We can also set up service-level agreements for larger projects that require maintenance contracts.



Extended Warranty*

All of our commercial display products come with a 3 year commercial warranty as standard but if you want to extend this you can upgrade this to cover a 5 year period at point of purchase.



Training

As well as providing free remote CMS training sessions and webinars we can also visit you to deliver bespoke training for our software and hardware*.



Advanced Replacements†

Should your display suffer from any kind of hardware failure during the warranty period we will send you an advanced replacement and arrange for your old display to be collected, free of charge. This ensures no downtime where you are without a screen.



Custom Product Testing & Configuration

If you need us to test third party software or a website, or configure your screen in a particular way before it is dispatched (e.g. in a particular orientation or network mode), we can do so to make your life easier.



3D Rendering

Want to know how a particular screen will look once installed? Send us a photo of the location and we will create a 3D rendering of any screen in situ to help you to visualise how amazing it will look.



Logistics Support

We hold more stock in our UK warehouse than any other manufacturer so we can help you meet tight deadlines. For last minute orders we can also offer special express or morning delivery options*. We also carry out UK based quality control checks on every display before it leaves our warehouse.



Project Support

If you need to loan a sample unit to test we'd be more than happy to arrange this. We can also provide a rental service for temporary projects*.



Customisation*

Your display can be customised to suit your requirements by adding your logo or printed graphics or even tailoring the colour of a display. We can also carry out hardware modifications to existing products or manufacture bespoke solutions for special projects.



Extras*

As well as being able to provide accessories and add-ons, such as extra remote controls, NUC PCs and video wall controllers, we can also supply custom made flight cases which are great if a display needs to be moved safely from place to place.

†UK mainland only

*These particular services may incur additional charges