

15" Digital Rod Displays

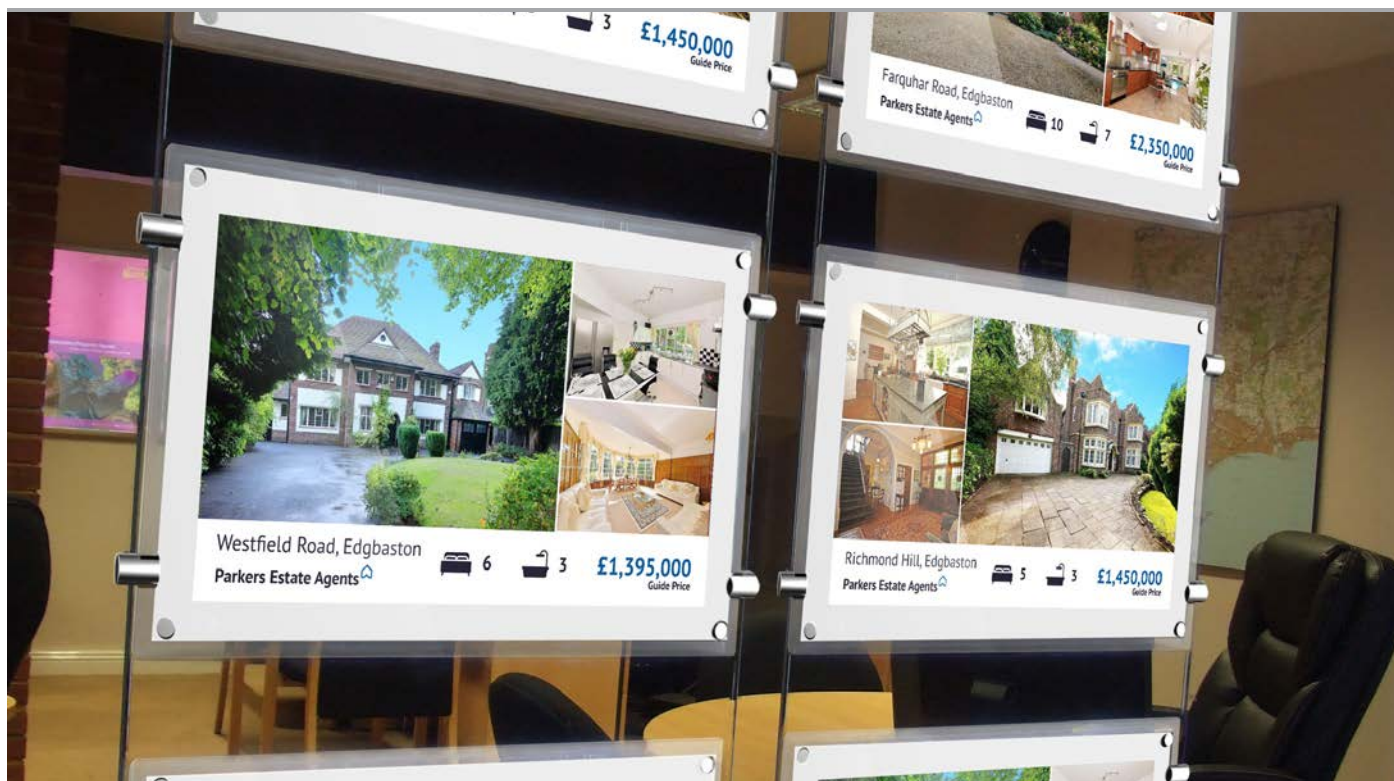

Bring estate agent windows to life with the state-of-the-art digital signage technology that replace traditional light pockets

Rod Powered Displays

No mains cable is required to provide power as these innovative screens are powered via the rods on which they are mounted. Achieve a clean and seamless installation with no cables whatsoever for a modern and sleek feel.



Sunlight Readable Digital Light Pockets

Catch the attention of passers-by and potential customers with these 1,000cd/m² high brightness LCD digital light pockets. Ideal for combining with static light pockets in window displays to provide eye-catching motion alongside printed signage.



Ideal for Estate Agents



Rear Graphics Pocket



Android Media Player



LED Frame



Integrated Speakers



Temperature Control



Wide Viewing Angle



Free Scheduling Software



Multi-Screen Synchronisation



Network Upgrade

Other Features

Free Network Upgrade

The capability of updating this screen remotely over the internet is included at no extra cost. Just choose the software subscription package that suits your needs so you can realise the benefits of our online content management system.



1,000cd/m² Commercial Panel

Brightness is paramount when using outward facing screens, these displays use commercial grade high brightness panels (1,000cd/m²); almost 4 times brighter than a standard home TV to allow easy readability in window displays.



Rear Graphics Pocket

On the rear of the display there is a pocket that a printed graphic can be inserted into to really maximise on the space used. This can be removed if necessary but comes as standard at no extra cost.



24/7 Usage

These displays use a commercial grade LCD panel and LED backlight. They have the ability to be in constant use 24/7 for over 70,000 hours and are designed for commercial use.



Exclusive Template Library

As well as being able to create your own layouts you can choose from our exclusive library of pre-design editable templates. Choose an existing layout, add your own images and information then publish it to your screen.



LED Frame

These displays have an attractive LED illuminated bevelled edge to compliment traditional static light pockets seamlessly.



Synchronise Multiple Displays

Synchronise your content across multiple screens in the same window display. You can achieve the effect of one large image or video across multiple screens or have content playing and transitioning in perfect unison.



USB Plug and Play

If you don't want to use our online CMS these displays can be updated quickly and easily by copying your images and videos over via USB stick. Even if you are using the network option this is a great backup if there are any internal network related issues.

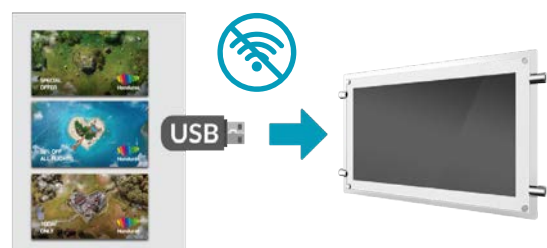

Key Features



ROD POWERED DISPLAYS



SUNLIGHT READABLE (1,000CD/M²)



LED FRAME



REAR GRAPHICS POCKET



ANDROID MEDIA PLAYER

PLUG AND PLAY

24/7 USAGE

OPTIONAL NETWORK UPGRADE

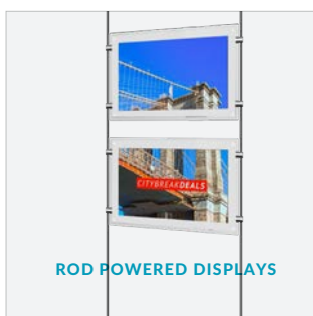

ROD POWERED DISPLAYS



SUNLIGHT READABLE

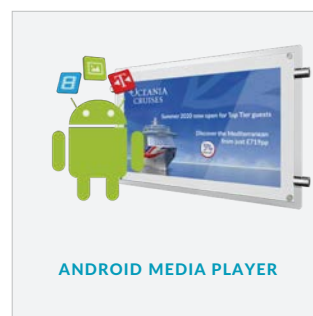

ANDROID MEDIA PLAYER

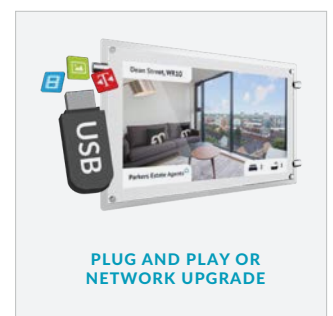

PLUG AND PLAY OR NETWORK UPGRADE

Specification Table

		15 Inch
Panel	Resolution	1920x1080
	Display Area (mm)	344x193.5
	Aspect Ratio	16:9
	Brightness (cd/m ²)	1000
	Colour	16.7M
	Viewing Angle	178°
	Contrast Ratio	5000:1
Audio	Speaker Type	5W, 8Ω (x2)
AV Inputs	Video	HDMI, VGA
	Audio	Audio Socket (3.5mm)
Power	Power Consumption (W)	16
	Input Voltage (with transformer)	12V (DC)
Mechanical	Unit Size (WxHxD mm)	430x280x49.2*
	Package Size (WxHxD mm)	510x360x185
	Net Weight (kg)	3.3
	Gross Weight (kg)	6.1
Environmental	Operating Temperature	0 °C to 50 °C
	Storage Temperature	-30°C to 60°C
	Operating Humidity	10% to 80%
	Storage Humidity	5% to 95%
Computer	Media Formats	Video (MPG, AVI, MP4, RM, RMVB, TS), Audio (MP3, WMA), Image (JPG, GIF, BMP, PNG)
	Media Resolution	1920x1080/1080x1920
	Internal Memory	6GB
	CPU	Quad-Core Cortex-A17@1.61GHz
	GPU	Mali-T760 MP4 @600MHz
	RAM	2GB DDR3
	Internal Storage	8GB NAND
	USB	USB2.0 HOST (x2)
	LAN	10/100M Ethernet (Network Version Only)
	Wi-Fi	802.11b/g/n/ac (Network Version Only)
	OS	Android 5.1.1
	Graphic Engine	OpenGL ES 1.1/2.0/3.0/3.1, OpenCL 1.1, Renderscript, Direct3D 11.1
	Accessories	Included
Optional		Network Upgrade
Warranty	Warranty Period	3 Year Warranty
	Technical Support	Lifetime

*Includes Rear Graphics Pocket
Errors and omissions excepted

Compatible with Estate Agent Software

The Digital Rod Displays are compatible with a host of third party estate agent property management software.



Technical Drawing

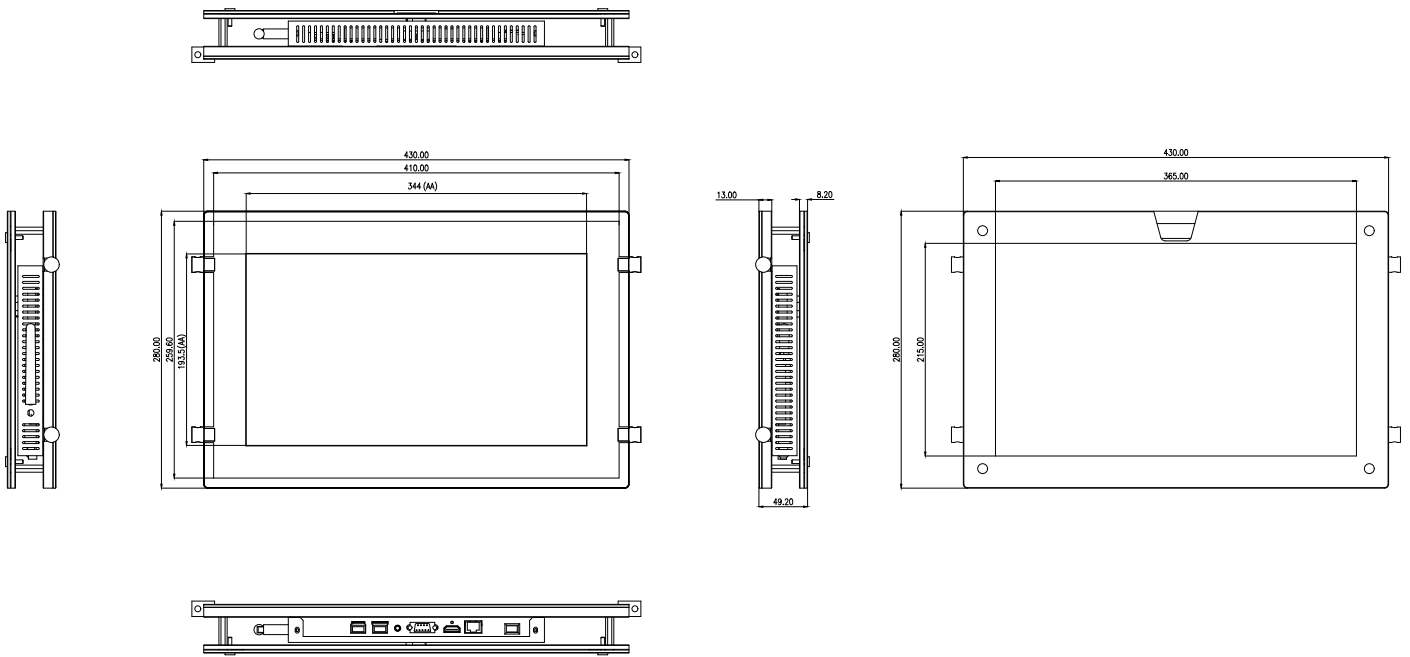

Why Choose Our Commercial Display Solutions?



Lifetime Technical Support

From the moment you receive your product, throughout the duration of your warranty and even after your warranty has expired we are here to support you. If you require any assistance setting up or using your product, or have any problems at all, we can provide free technical support via telephone and email.

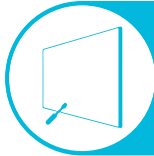

On-site Support and Maintenance*

If needed, we can provide an installation service for any of our products. We can also set up service-level agreements for larger projects that require maintenance contracts.



Extended Warranty*

All of our commercial display products come with a 3 year commercial warranty as standard but if you want to extend this you can upgrade this to cover a 5 year period at point of purchase.



Training

As well as providing free remote CMS training sessions and webinars we can also visit you to deliver bespoke training for our software and hardware*.



Advanced Replacements†

Should your display suffer from any kind of hardware failure during the warranty period we will send you an advanced replacement and arrange for your old display to be collected, free of charge. This ensures no downtime where you are without a screen.



Custom Product Testing & Configuration

If you need us to test third party software or a website, or configure your screen in a particular way before it is dispatched (e.g. in a particular orientation or network mode), we can do so to make your life easier.



3D Rendering

Want to know how a particular screen will look once installed? Send us a photo of the location and we will create a 3D rendering of any screen in situ to help you to visualise how amazing it will look.



Logistics Support

We hold more stock in our UK warehouse than any other manufacturer so we can help you meet tight deadlines. For last minute orders we can also offer special express or morning delivery options*. We also carry out UK based quality control checks on every display before it leaves our warehouse.



Project Support

If you need to loan a sample unit to test we'd be more than happy to arrange this. We can also provide a rental service for temporary projects*.



Customisation*

Your display can be customised to suit your requirements by adding your logo or printed graphics or even tailoring the colour of a display. We can also carry out hardware modifications to existing products or manufacture bespoke solutions for special projects.



Extras*

As well as being able to provide accessories and add-ons, such as extra remote controls, NUC PCs and video wall controllers, we can also supply custom made flight cases which are great if a display needs to be moved safely from place to place.

†UK mainland only

*These particular services may incur additional charges